

See More and Share More in 4K

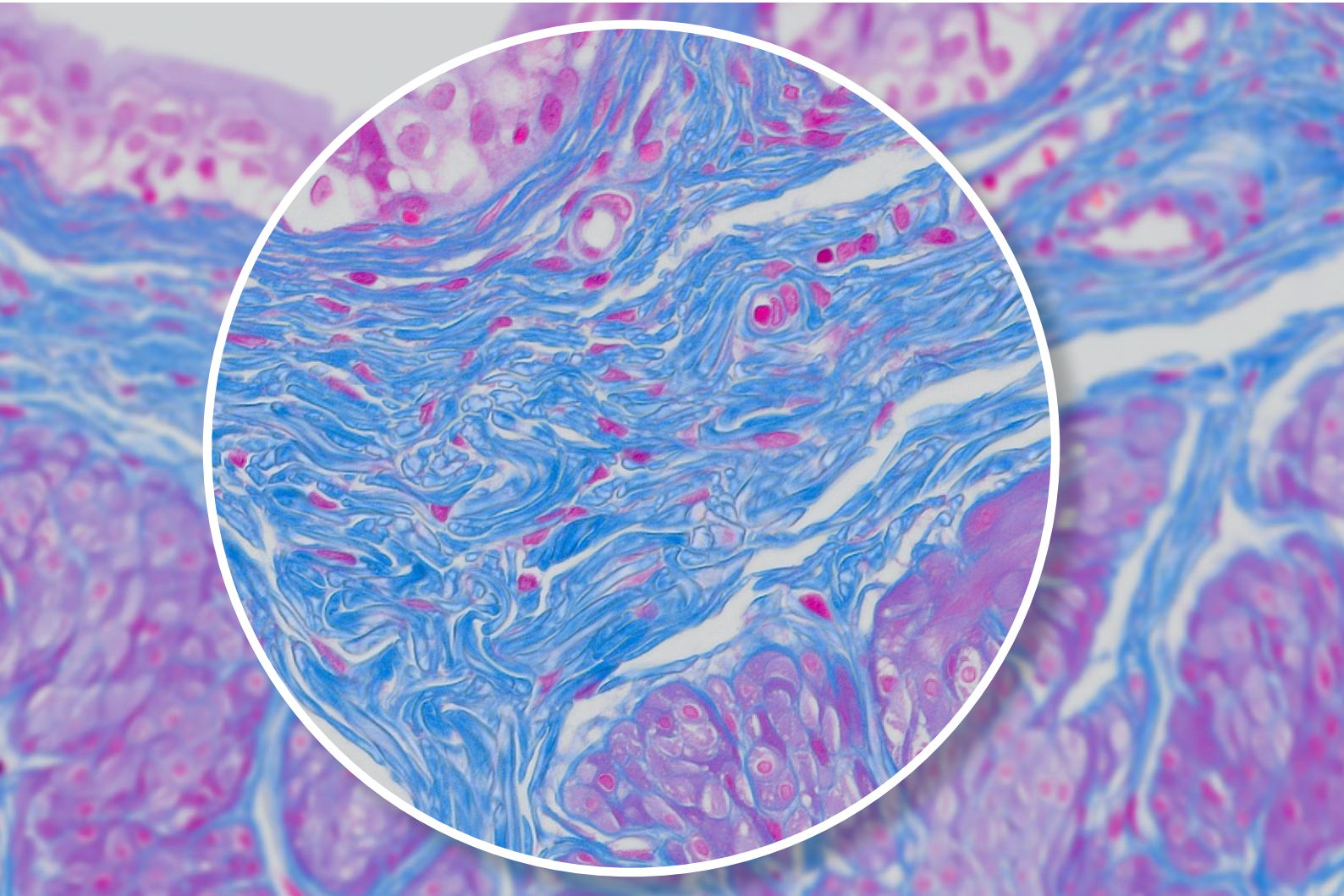

4K Resolution for Discussion

The DP28 digital microscope camera combines powerful features, precise color accuracy, and 4K resolution across a wide field of view to provide stunning images for conferencing, teaching, and clinical research. With smart features, the camera eases and accelerates your microscopy tasks while delivering high-quality images.

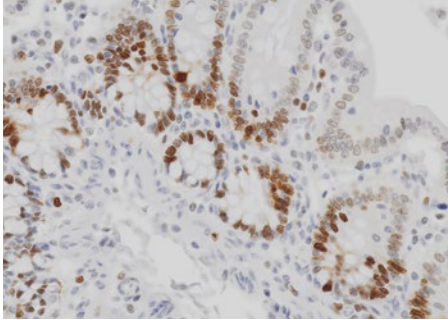

Rat colon/ Ki-67/ 20x

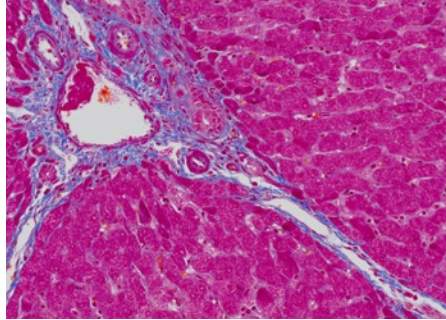

Pig liver/ MT/ 40x

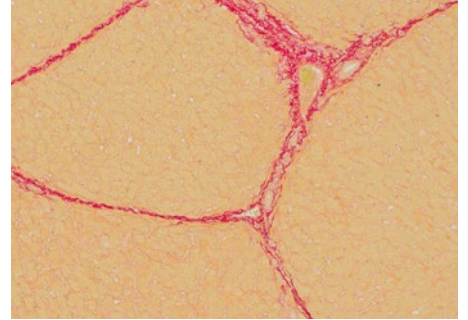

Pig liver/ Picrosirius red/ 40x



From the Oculars to Your Monitor: Discuss the Details of Your Samples in 4K

Comfortably View Images on Screen

Whether you're presenting at a conference, teaching, or discussing among colleagues, 4K image resolution creates images on the screen that look exactly as they appear through the microscope's eyepieces, so you know you're not missing details or data. Smooth live images with no distortion make collaboration easy thanks to the camera's 8.9-megapixel CMOS sensor, global shutter, and 4K resolution at 32 frames per second (fps). The camera can provide up to 64 fps full HD live images, which is the maximum framerate a standard monitor can display.

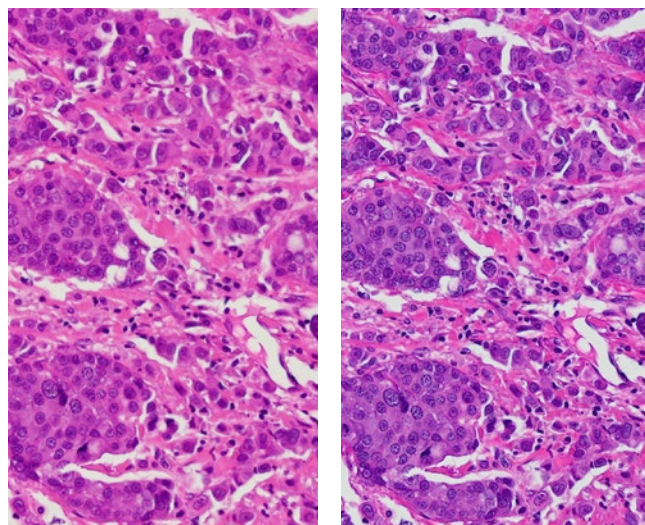

Conventional camera

DP28 camera

Get More from Your Sample

Within an incredibly large field of view (FOV) up to FN25, you can see and capture more of your sample with images that are sharp, flat, and in focus from the center to the periphery for efficient analysis. With Olympus' X Line high-performance objectives and an 0.63X camera adaptor designed for a wide FOV, you can leverage the potential of the camera's 1-inch image sensor.

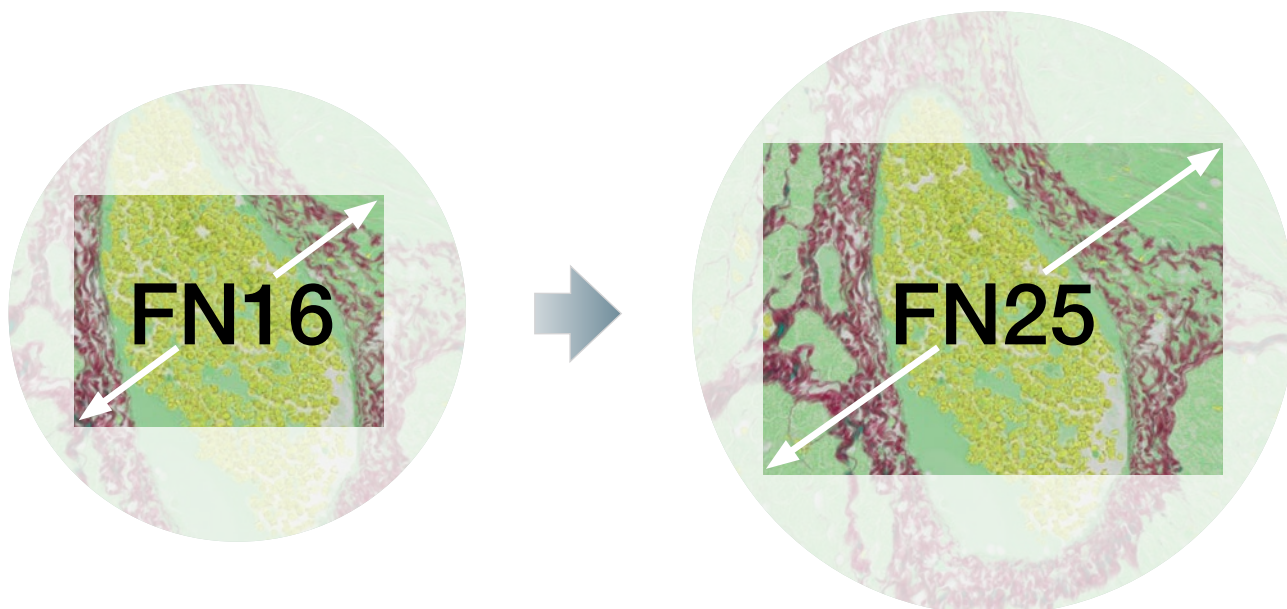

*Your microscope system must be compatible with an FN25 FOV.

Color Reproduction that Rivals the Human Eye

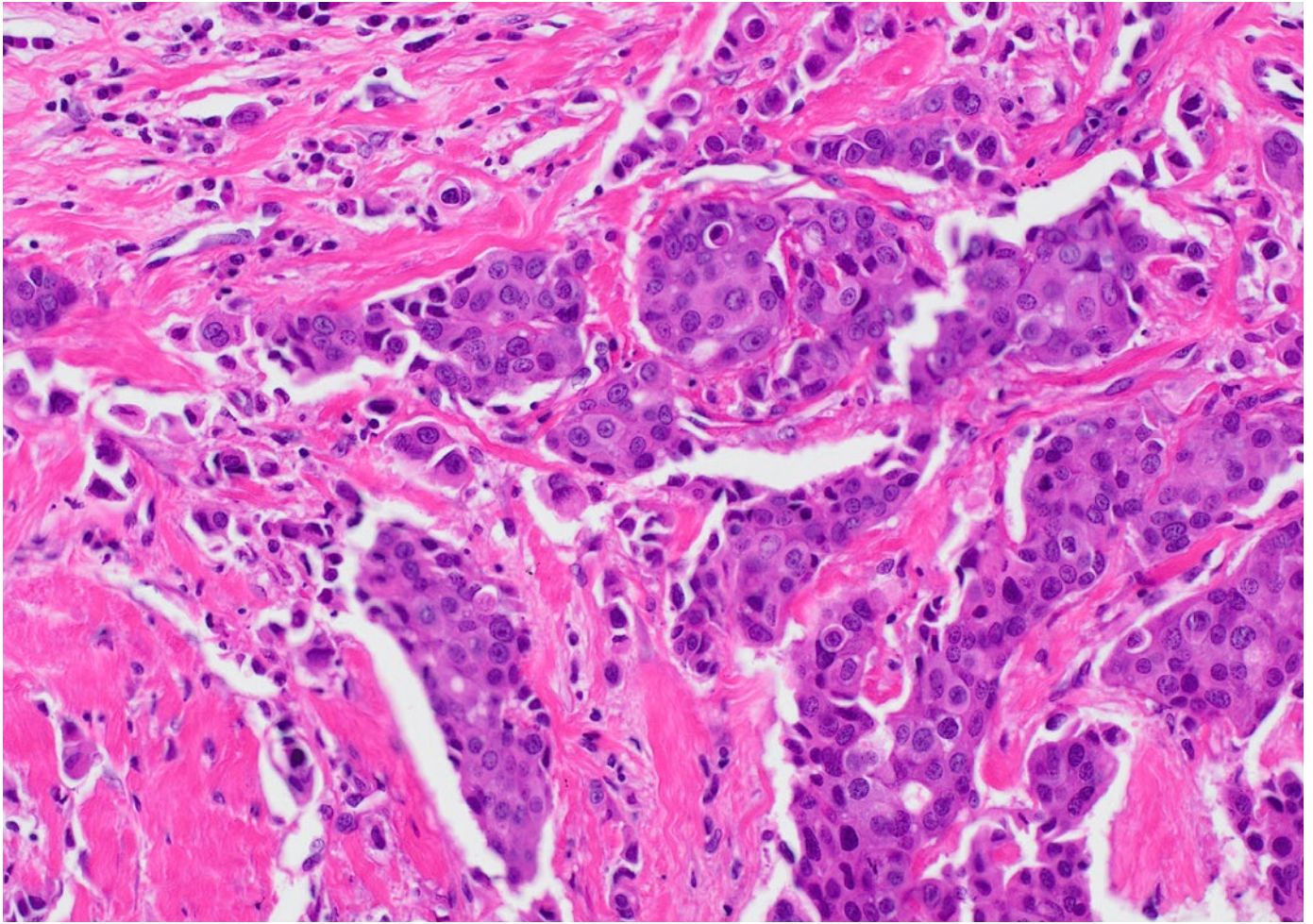

Colors You Can Trust

Like all cameras in the DP series—which are famous for their color reproduction for clinical research and life science samples—the DP28 camera realizes reliable color on your monitor. Dedicated ICC profiles show your samples in their natural colors, so the dyes you use look the way you expect them to. With Olympus' TruColor LED light source for the BX53 microscope, the DP28 camera is part of a complete system that provides high color reproduction from the light source to the camera.

Image Capture Made Easy with Smart Features

Smart Image Technology

Olympus Smart Image Averaging (OSIA)* suppresses noise while maintaining a fast frame rate and eliminating artifacts. OSIA automatically maximizes the camera's image quality with no adjustments.

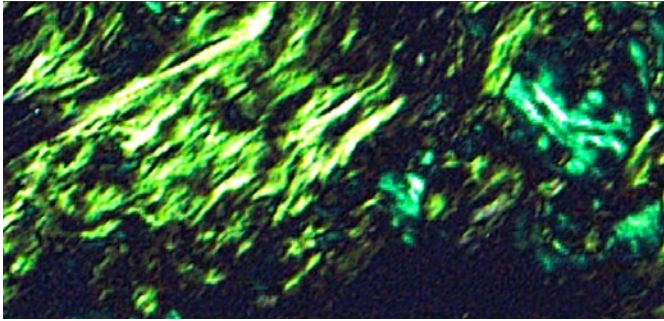

Without OSIA

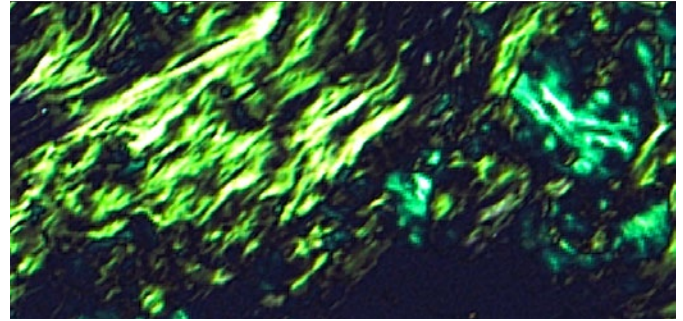

With OSIA

Capture Clear Images from Dim Samples

During polarization and fluorescence microscopy, the High Contrast mode enables easier image acquisition with a high signal-to-noise ratio so that you can capture high-quality images from dim samples. The feature automatically adjusts the exposure time and applies the proper contrast setting.

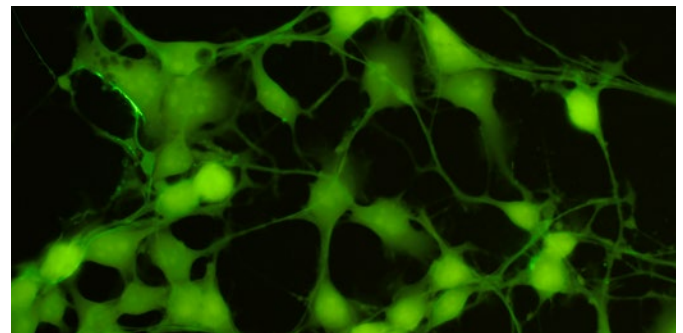

Smooth Live Images

The Fast Live function provides a consistently high displayed frame rate during long-exposure imaging, so your image remains smooth when scanning samples, even under low light conditions. The result is a smooth image when scanning samples.

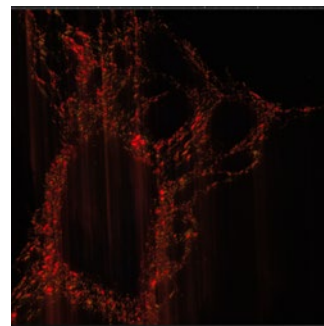

Fast Live off

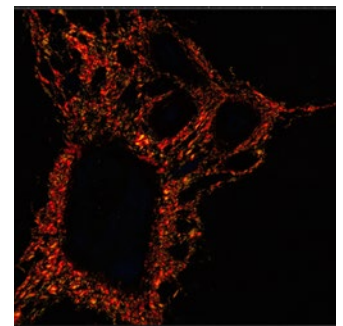

Fast Live on

Easy Precision Focusing

If you're observing thick specimens, the Focus Peaking function* helps you identify which sample regions are currently in focus. The software indicates the in-focus areas in color and the out-of-focus areas in grayscale in an overlay of the live image.

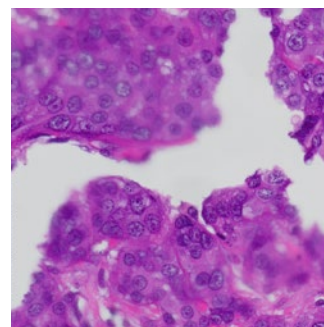

Without Focus Peaking

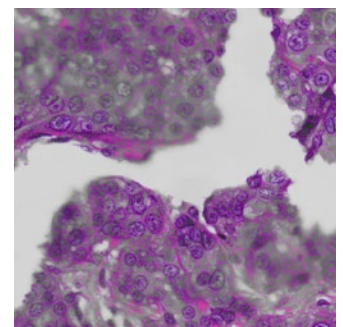

With Focus Peaking

*Available in cellSens imaging software.

Simple to Set Up and Use

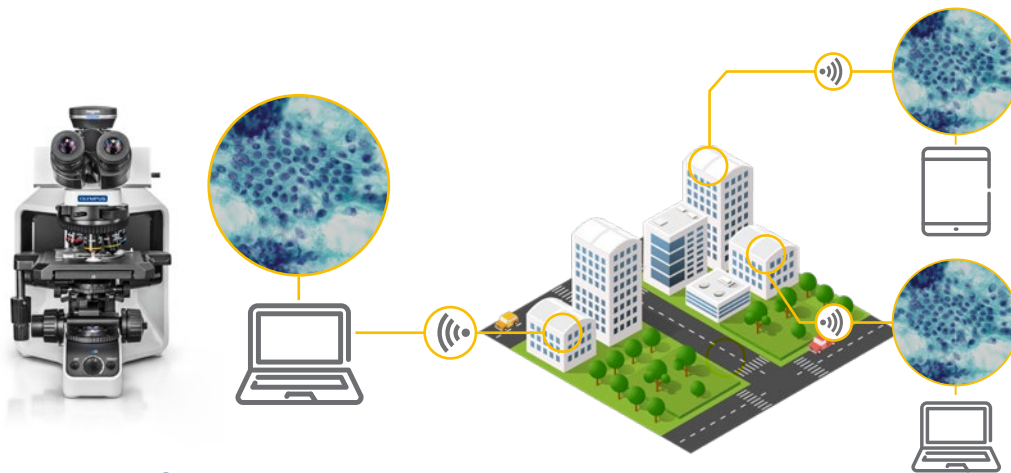

Fast, Efficient Remote Collaboration

All your critical data—images, annotations, and live measurements—can be displayed and shared together locally or remotely using cellSens software with the NetCam solution or the standalone camera control module's remote image sharing feature.*¹ This provides a simpler way to discuss and share smooth 30 fps, full HD, live images with colleagues rather than relying on email attachments. And thanks to support for network security protocols such as NIST and GDPR along with antivirus support, you can share your data safely.*¹

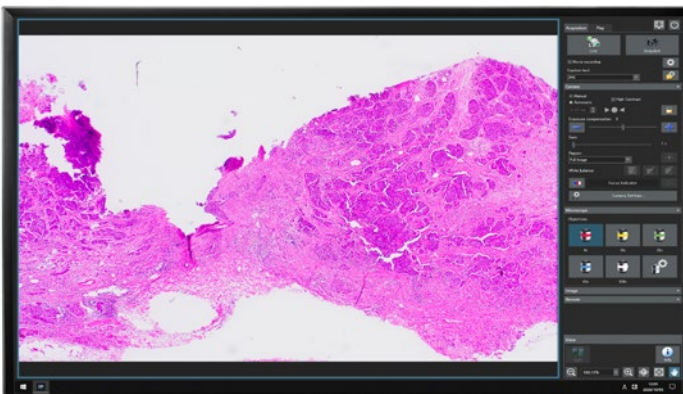

One-Click Image Acquisition

The camera's thoughtfully designed software makes image acquisition simple. In most cases, you can acquire images with just a single click for an efficient workflow. Whether you choose the advanced functionality of Olympus cellSens software or the targeted functionality of the standalone DP28-AOU (Advanced Operation Unit) camera module, both have a simple user interface that makes the software easy to use.



Save Valuable Work Space with a PC-Less Configuration

You can attach the camera's standalone module to the back of your monitor to free up valuable desk space—a separate PC is not required.

Plug and Play Simplicity

Just plug the camera cord into your computer's USB 3.1 port*², and it's ready to use. No separate AC adaptor is required.

*1 Remote image sharing and antivirus software are optional.

*2 USB3.1 Gen1 is compatible with USB3.0.

DP28 Specifications

DP28-CU

Type	8.9-megapixel color camera	
Imaging sensor	Sensor type	1-inch color color CMOS
	Shutter type	Global Shutter
	Pixel size	3.45 μm \times 3.45 μm
	Dynamic range	10 bit
Sensitivity	Gain	1–24
Mount	Camera adaptor	C-mount
	Exposure mode	Manual, Auto
Exposure control	Exposure spot size	Full image, 30%, 1.0%, 0.1%
	Exposure adjustment	-2 to +2 (in 1/6 step)
	Auto exposure	AE lock, AE slow down
	Exposure time	Manual exposure: 27 μs –15 s Auto exposure: 27 μs –15 s
Camera I/F	USB 3.1 Type-C ^{*1} (cable length: 2.9 m (9.5 ft))	
Dimensions	Camera head (W \times D \times H)	76.7 mm \times 70.1 mm \times 37.3 mm (3 in. \times 2.8 in. \times 1.5 in.)
	Control unit (W \times D \times H)	180 mm \times 180 mm \times 53 mm (7 in. \times 7 in. \times 2 in.)

	PC connection	Standalone
Image size (W \times H)	4104 \times 2174 (full resolution)	4104 \times 2174 (full resolution)
	3840 \times 2160 (4K)	3840 \times 2160 (4K)
	2168 \times 2168 (square)	2168 \times 2168 (square)
	2052 \times 1086 (sub-sampling 2 \times 2—high speed)	2052 \times 1086 (sub-sampling 2 \times 2—high speed)
	2052 \times 1086 (binning 2 \times 2—high sensitivity)	2052 \times 1086 (binning 2 \times 2—high sensitivity)
	1920 \times 1080 (full HD)	1920 \times 1080 (full HD)
Live image display (frame rate) ^{*2}	32 fps (full resolution)	30 fps (full resolution)
	33 fps (4K)	30 fps (4K)
	33 fps (square)	30 fps (square)
	64 fps (sub-sampling 2 \times 2—high sensitivity)	60 fps (sub-sampling 2 \times 2—high speed)
	32 fps (binning 2 \times 2)	30 fps (binning 2 \times 2—high sensitivity)
	64 fps (full HD)	60 fps (full HD)
Compatible image display	Depends on the PC's specifications.	3840 \times 2160 4K UHD TV, 2560 \times 1440 WQHD, 1920 \times 1200 WUXGA, 1920 \times 1080 FHD, 1680 \times 1050 WSXGA+, 1440 \times 900 WXGA+, 1366 \times 768 FWXGA, 1280 \times 854 HDTV (720 p), 1600 \times 1200 UXGA, 1280 \times 1024 SXGA
Storage media	Depends on the PC's specifications.	Integrated device for storing images (SSD: 60 GB) External USB storage device PC connected to network
Controller interface	USB3.1 Gen1	Display output: 2 \times HDMI Peripheral I/F: 4 \times USB3.1 Gen1 Wired LAN: 2 \times LAN (1000BASE-T/100BASE-TX/10BASE-T) Serial port: RS-232C Audio: Mic. input (monaural), phone jack
	Scale bar	Supported
Scale display	Info stamp	Document name, total magnification, objective magnification, zoom magnification
	Zooming magnification	10% to 1600%
Measuring function	According to cellSens ^{*3} specifications	Measurement function count, distance between 2 points, polyline, 3-point circle, rectangle, 3-point angle, 4-point angle, perpendicular, area and perimeter of polygon, distance between 2 centers, ruler
PC requirements	CPU [®] Intel [®] Xeon, Intel [®] Core i5, i7, i9 RAM: 8GB Recommended: • 6 or more physical CPU cores • RAM: 16GB (8GB \times 2: dual channel)	

Remote function	PC connection	Standalone
Optional license	cellSens Netcam (remote function) ^{*3,4}	Network solution (remote function) ^{*5} Antivirus software (white list type)
Web browser (client computer)	Microsoft Edge (chromium) Google Chrome Safari	Microsoft Edge (chromium) Google Chrome Safari
Customer PC OS requirements	Windows 10 Pro 64-bit, Android 9.0 or higher, iOS 12.0 or higher.	Windows 10 Pro 64-bit, Android 9.0 or higher, iOS 12.0 or higher

*1 USB 3.1 Gen 1 is compatible with USB 3.0

*2 Frame rate may decrease depending on the condition of your PC and/or software. It is recommended to use a dual-channel memory configuration for your PC.

*3 cellSens software is not for clinical diagnostic use.

*4 cellSens v. 3.1.1 or later.

*5 Network must be within an Intranet. For a wireless connection, a USB wireless LAN adaptor is also required.

DP28 Standalone Configuration System Diagram

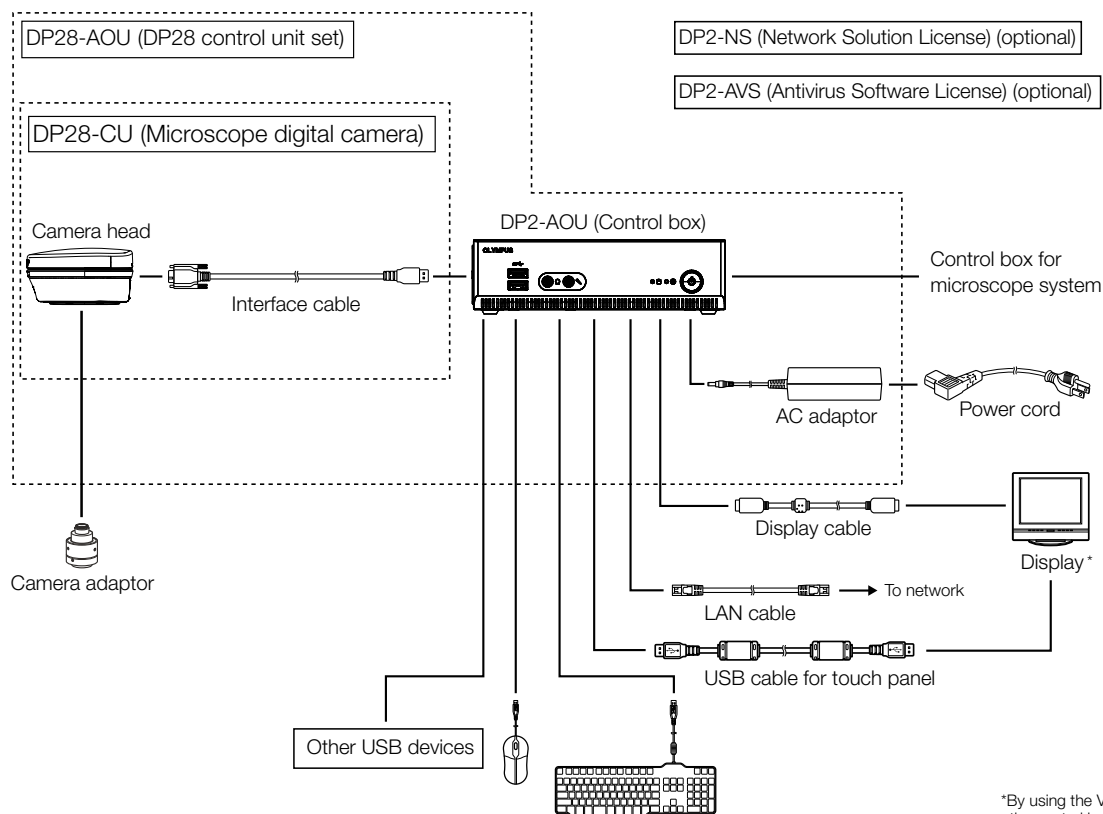

DP28 PC Configuration System Diagram

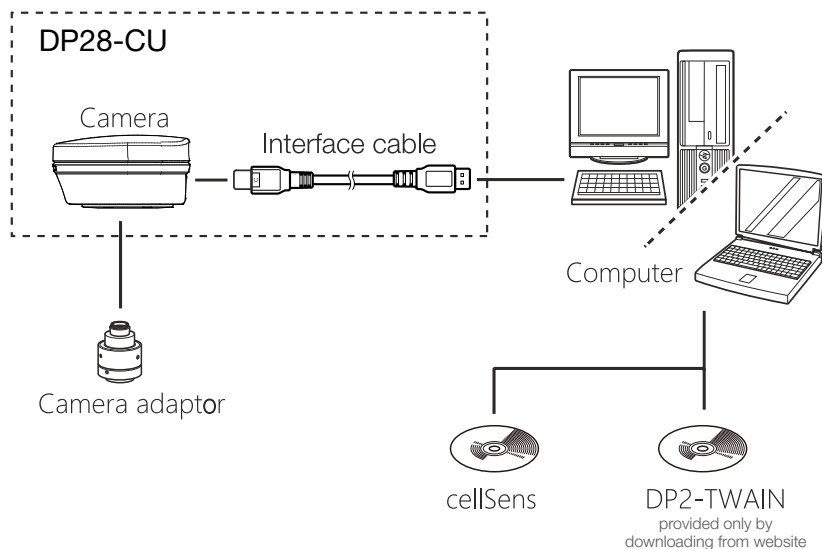

- OLYMPUS CORPORATION is ISO14001 certified.
- OLYMPUS CORPORATION is ISO9001 certified.



- Microsoft and Windows are registered trademarks of Microsoft Corporation in U.S. The terms HDMI and HDMI High-Definition Multimedia Interface, and the HDMI Logo are trademarks or registered trademarks of HDMI Licensing Administrator, Inc. in the United States and other countries. The SuperSpeed USB 5Gbps Trident Logo is a registered trademark of USB Implements Forum, Inc. All brand names or product names described in this instruction manual are trademarks or registered trademarks of relevant owners.
- All company and product names are registered trademarks and/or trademarks of their respective owners. Olympus, the Olympus logo, cellSens, and OLYMPUS Stream are trademarks of Olympus Corporation or its subsidiaries.
- Specifications and appearances are subject to change without any notice or obligation on the part of the manufacturer.

EvidentScientific.com



EVIDENT CORPORATION
Shinjuku Monolith, 2-3-1 Nishi-Shinjuku, Shinjuku-ku, Tokyo 163-0914, Japan

Printed in Japan N8602101-042022