

ThermTec

WILD Series

Thermal Imaging Monocular

Wild Series User Manual



Download on the
App Store

GET IT FOR
Android



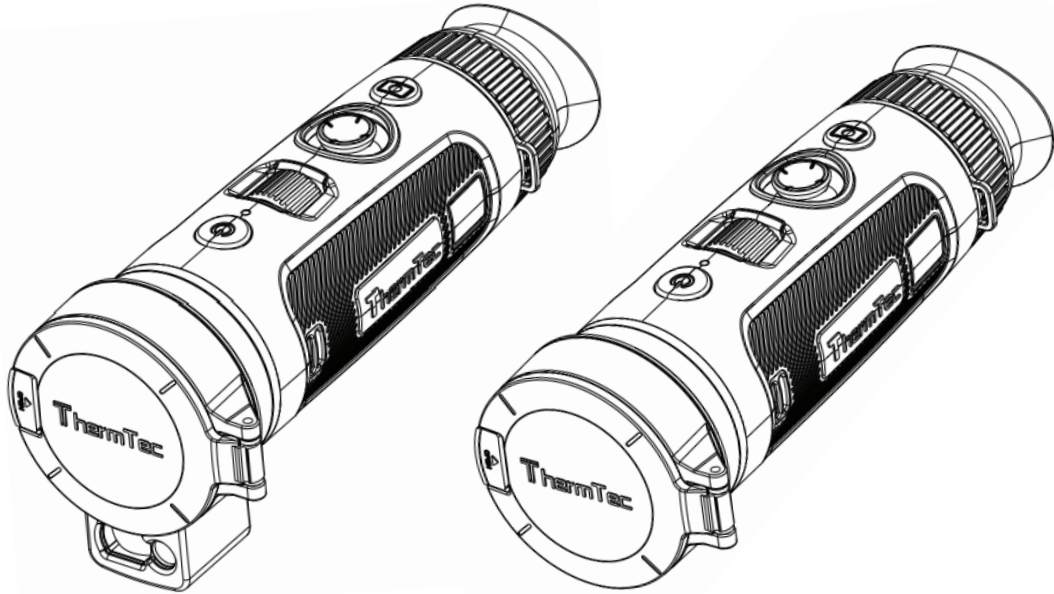

Content

About This Manual	05	3.3.3.2 AI Ranging and Laser Rangefinder	13
Regulatory Information	06	3.3.3.3 Pseudo Color Switch	13
1. Introduction	07	3.3.3.4 Target Outline Mode	14
1.1 Device Description	07	3.3.4 Capture/Record	15
1.2 Features	07	3.4 Set	15
1.3 Application Scenarios	07	3.4.1 Setting	15
1.4 Appearance	08	3.4.2 System Setting	17
2. Packing List	09	3.4.3 Network Connection	25
3. Operation Guide	10	3.4.3.1 App Download	26
3.1 Charging	10	3.4.3.2 Connect via Hotspot	26
3.2 Power on/off	11	3.4.4 File Management	27
3.3 Buttons and Controls	11	3.5 External Video & Data Reading	29
3.3.1 Buttons Combinations and Introduction	11	3.6 System Software Upgrade	29
3.3.2. Lens Adjustment	12	4. Technical Data	31
3.3.3 Joystick Operation	12	4.1 Product Size & Drawing	31
3.3.3.1 Zoom	12	4.2 Specifications	33

About This Manual

COPYRIGHT © 2024 ThermTec Technology Co., Ltd. ALL RIGHTS RESERVED.

Any and all information, including, among others, wordings, pictures, graphs are the properties of ThermTec Technology Co., Ltd. or its subsidiaries (hereinafter referred to as “ThermTec”). This user manual (hereinafter referred to be “the Manual”) cannot be reproduced, changed, translated, or distributed, partially or wholly, by any means, without the prior written permission of ThermTec. Unless otherwise stipulated, ThermTec does not make any warranties, guarantees or representations, express or implied, regarding to the Manual. This Manual is applicable to Thermal Imaging Monocular.

The Manual includes instructions for using and managing the product. Pictures, charts, images and all other information hereinafter are for description and explanation only. The information contained in the Manual is subject to change, without notice, due to firmware updates or other reasons.

ThermTec

WILD

Regulatory Information



This product and, if applicable, the supplied accessories are marked with “CE” and comply therefore with the applicable harmonized European standards listed under the Radio Equipment Directive 2014/53/EU, the EMC Directive 2014/30/EU, the RoHS Directive 2011/65/EU.



This product and - if applicable - the supplied accessories too are marked with “UKCA” and comply therefore with the following directives: Radio Equipment Regulations 2017, Electromagnetic Compatibility Regulations 2016, Electrical Equipment (Safety) Regulations 2016, the Restriction of the Use of Certain Hazardous Substances in Electrical and Electronic Equipment Regulations 2012.



This product and - if applicable - the supplied accessories too are marked with “RoHS” and comply therefore the requirements of Directive 2011/65/EU on the restriction of the use of certain hazardous substances in electrical and electronic equipment (“RoHS recast” or “RoHS 2”).



2012/19/EU (WEEE directive): Products marked with this symbol cannot be disposed of as unsorted municipal waste in the European Union. For proper recycling, return this product to your local supplier upon the purchase of equivalent new equipment, or dispose of it at designated collection points. For more information see: www.recyclethis.info.



Directive 2006/66/EC and its amendment 2013/56/EU (Battery Directive): This product contains a battery that cannot be disposed of as unsorted municipal waste in the European Union. See the product documentation for specific battery information. The battery is marked with this symbol, which may include lettering to indicate cadmium (Cd), lead (Pb), or mercury (Hg). For proper recycling, return the battery to your supplier or to a designated collection point. For more information see: www.recyclethis.info.

1 Introduction

1.1 Device Description

Wild Series Thermal Imaging Monocular is designed with a NETD less 18mk, 12μm uncooled infrared detector and 1024x768 OLED high-definition display. With AI image recognition algorithm, it gets clear views under various lighting conditions, even in complete darkness, providing reliable and high-quality visual images for night activities. It can also view the moving target and meet the outdoor conditions. The apparatus can be widely used for searching and rescuing, hunting, etc.

1.2 Features

- 12μm uncooled infrared detector, NETD less than 18mk;
- 1x--4x continuous digital zoom;
- LRF-Boost, AI and laser rangefinder combination;
- Various pseudo colors;
- Joystick control design, wheel focusing realizes one-hand operation;
- Detector anti-burn mechanism;
- Super large aperture offers better temperature radiation capturing capability;
- 1024*768 resolution with 0.39 inch OLED display;
- Up to 10h continuous working for lithium battery;

1.3 Application Scenarios

- Animal Observation
- Outdoor Adventure
- Security Law Enforcement
- Emergency Search and Rescue

1.4 Appearance

- ① Lens cover
- ② Power button
- ③ Focusing knob
- ④ Joystick
- ⑤ Capture/Record button
- ⑥ Diopter knob
- ⑦ Eyepiece cover
- ⑧ Compartment of replaceable battery
- ⑨ Type-C port
- ⑩ Laser module



2 Packing List



WILDSeries



Lens cloth (x1)



Monocular (x1)



User manual (x1)



Lanyard(x1)



Hand strap (x1)



Bag (x1)



Charger (X1)



USB cable (x1)



Lithium battery (X2)

3 Operation Guide

3.1 Charging

Here are two methods we could take to charge the device. **Device Charging** and **Battery Charging**.

Device Charging:

Connect the device and power adaptor directly with a type-C cable to power on the device. Alternatively, connect the device and PC to export files. Follow the below steps to charge the battery:



- Lift the cover from the USB port.
- Plug the cable provided into the USB port.
- Plug the opposite end of the cable into a USB power source.

Battery Charging:

Wild series have adopted replaceable and changeable battery design. The batteries could be taken off and charged directly, from which dramatically improves the device life.



Note:

- The battery should be fully charged prior to use.
- The battery is supposed to be taken out for long time non-using occasions.

3.2 Power on/off

Press and hold the power button to power on/power off the device.



3.3 Buttons and Controls

3.3.1 Buttons Combinations and Introduction

Before entering the main menu							
	Short Press		Long Press		Double Press		
Power Button	Standby Mode		On/Off		N/A		
Capture Button	Capture		Record		N/A		
Joystick	Up	Down	Left	Right		Center	
	Zoom in	Zoom out	AI Range finder	Short Push	Long Push	Brief Click	Double Click
				Pseudo Switch	Outline Mode	Calibration	Menu
After entering the main menu							
Joystick	Up	Down	Left	Right	Short Press		
	Move up	Move down	Exit sub-menu	Open Sub-menu	Confirm		

3.3.2. Lens Adjustment

Diopter Adjustment

Looking through the eyepiece, adjust the position of diopter level to optimize the image sharpness on the OLED display.



Objective Lens Focusing

Manually adjust the objective lens focus when you can't see the scene clearly.

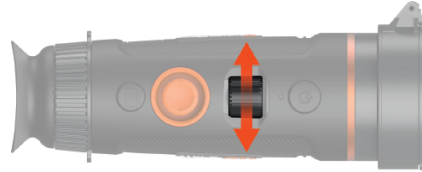

3.3.3 Joystick Operation

3.3.3.1 Zoom

Push the joystick to the front to zoom in, vice versa.

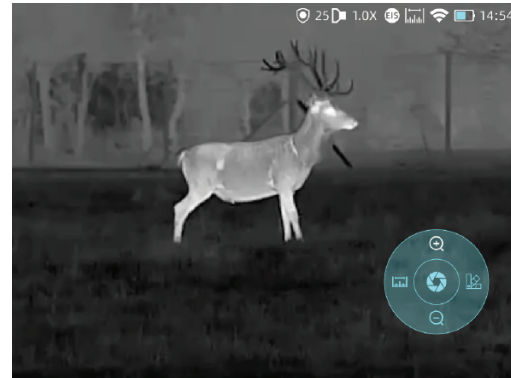
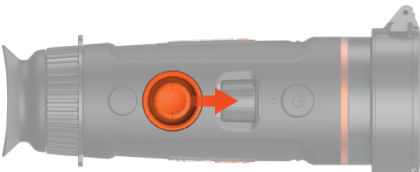

3.3.3.2 AI Ranging and Laser Rangefinder

Push the joystick to the left to activate AI rangefinder or laser rangefinder.

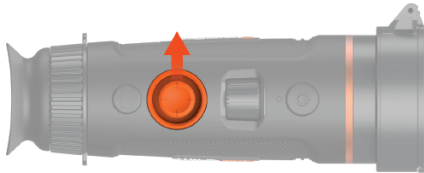

Note: the laser rangefinder is only available for Wild LRF series.



3.3.3.3 Pseudo Color Switch

Brief push joystick to right to switch pseudo colors.

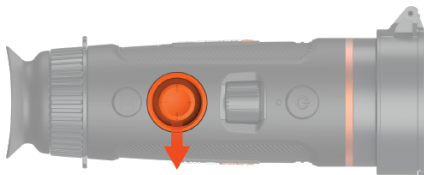

There are totally six pseudo colors (white hot, black hot, red hot, green, golden, violet) for user choice.



White



Black



Golden



Red



Green



Violet

3.3.3.4 Target Outline Mode

Long push the joystick to right to enter the target outline mode.

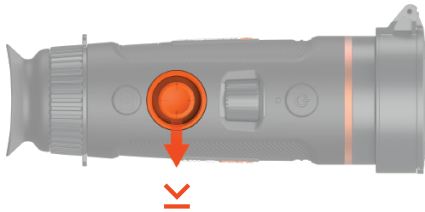

3.3.4 Capture/Record

Image Capturing

Press Capture button to take photos. Then the photo icon in the upper left corner will flash once.



Video Recording

Press and hold Capture button to take videos. Then the recording icon starts flashing in the upper left corner, and the recording starts timing. Press and hold again to stop recording.

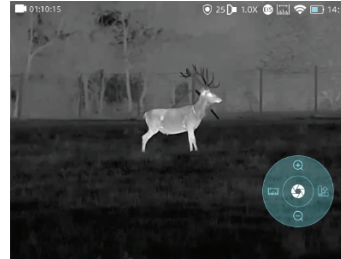

3.4 Set

Select setting and double-click the joystick to enter setting menu.

Note: Select by moving the joystick, and short press the joystick to confirm the selection.

3.4.1 Setting

Image Capturing

Press to enter the Imaging Setting menu. There are five sub-menus for image setting, which are “Image Mode”, “Sharpness”, “Denoise”, “Brightness” and “Contrast”.

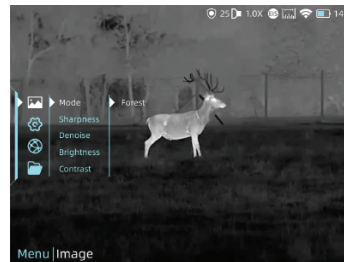





Image Settings		
	Forest	The image details would be enhanced in a way.
Sharpness	0-10	<p>Adjust image sharpness to make the image edge sharper. The recommended value is 5.</p> 
Denoise	0-10	Adjust image noise to make the image cleaner. The recommended value is 5.
Brightness	1-10	Adjust image brightness to make the image brighter. The recommended value is 5.
Contrast	1-10	Adjust image contrast to make the target more prominent in the image. The recommended value is 5.

3.4.2 System Setting

Press joystick to confirm **Setting** to enter the System Setting menu. Select by moving the joystick, and short-press the joystick to confirm the selection.

System Setting		
Correction		 <p>The image correction mode could be set by Auto or Manual.</p>
OSD	On-screen display	 <p>Enable this feature to decide if the menu icons display in the recorded videos.</p>

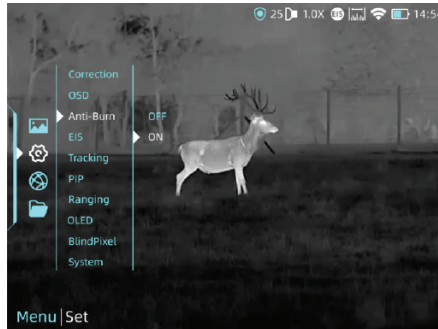

Anti-Burn



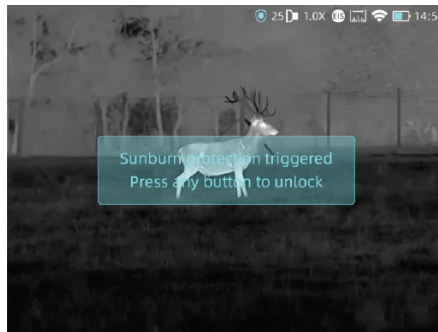

Detector anti-burn function, it could be set by on/off.



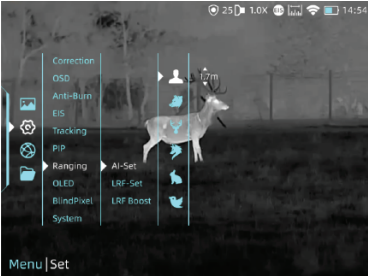
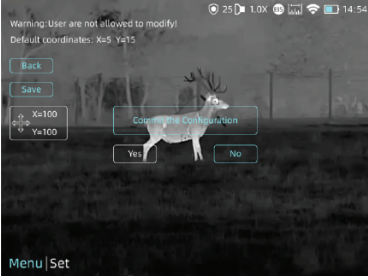
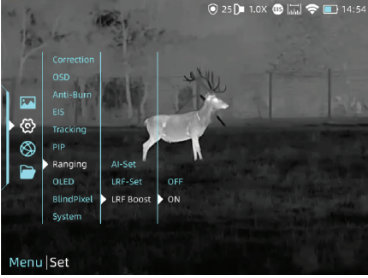

Once it detects harmful rays to the detector, the system will enable protection automatically.

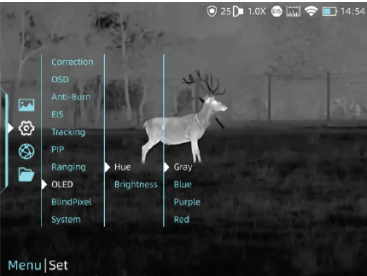
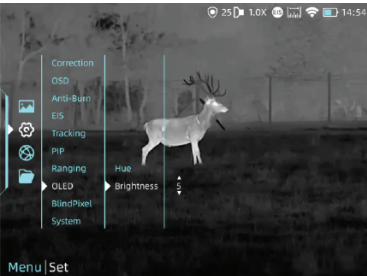

<p>EIS</p>	<p>Electronic Image Stabilization</p>	 <p>A screenshot of a camera's settings menu. The menu items are: Correction, OSD, Anti-Burn, EIS, Tracking, PIP, Ranging, OLED, BlindPixel, and System. The 'EIS' option is highlighted with a white arrow pointing to it, and its status is shown as 'OFF'. The background of the menu is a thermal image of a deer in a field. At the bottom of the menu, it says 'Menu Set'. The top status bar shows 25°C, 1.0X zoom, signal strength, Wi-Fi, and 14:54.</p>	<p>Electronic Image Stabilization. It could be switched on/off in the system setting.</p>
<p>Tracking</p>		 <p>A screenshot of a camera's settings menu, identical to the one above. The 'Tracking' option is highlighted with a white arrow pointing to it, and its status is shown as 'ON'. The background is the same thermal image of a deer. At the bottom, it says 'Menu Set'. The top status bar shows 25°C, 1.0X zoom, signal strength, Wi-Fi, and 14:54.</p>	<p>Turn on heat tracking to mark the target with the highest temperature in real time in the screen.</p>
<p>PIP</p>	<p>Picture in picture</p>	 <p>A screenshot of a camera's settings menu, identical to the ones above. The 'PIP' option is highlighted with a white arrow pointing to it, and its status is shown as 'ON'. The background is the same thermal image of a deer. At the bottom, it says 'Menu Set'. The top status bar shows 25°C, 1.0X zoom, signal strength, Wi-Fi, and 14:54.</p>	<p>In the picture, the image is 2x enlarged from the center of the cross.</p>

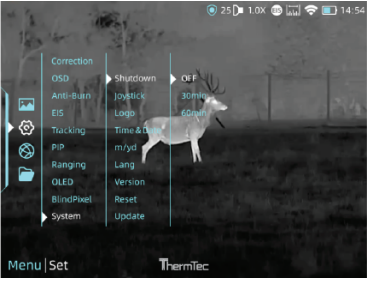
	AI-Set		<p>Customize the size of targets, and they all could be set by on/off.</p>
Ranging	LRF-Set		<p>It includes the default information of LRF location. Warning: No modification is allowed in this section.</p>
	LRF Boost		<p>Combined with an AI rangefinder, it could measure the aimed target precisely with laser rangefinder and calculate the distances of various targets in the same scene.</p>

<p>OLED</p>	<p>Hue</p>		<p>Gray, Blue, Purple and Red are optional for OLED hue.</p>
<p>OLED</p>	<p>Brightness</p>		<p>The brightness could be adjusted here to make the image brighter or darker. The value could be set by 1-5.</p>
<p>BlindPixel</p>			<p>The blind pixel in the picture can be replaced. We could replace blind pixels, save the current settings or cancel it.</p>

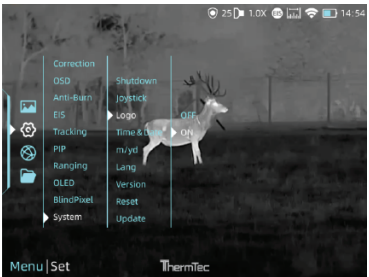
	Shutdown	 <p>The screenshot shows the Thermitec menu with 'Shutdown' selected. The 'Shutdown' submenu is open, showing options for 'DEF' (30mins), 'Joystick' (60mins), and 'Loop' (60mins). The background shows a deer in a field.</p>	<p>The device could be set to shutdown after 30mins, 60mins, or you could turn off the function.</p>
System	Joystick	 <p>The top screenshot shows the Thermitec menu with 'Joystick' selected. The 'Joystick' submenu is open, showing options for 'Loop', 'Time & Def', 'm/y/d', 'Lang', 'Version', 'Reset', and 'Update'. The background shows a deer in a field.</p> <p>The bottom screenshot shows a joystick sensitivity adjustment overlay. It features a central joystick icon with four blue arrows pointing up, down, left, and right, indicating the sensitivity range for each direction.</p>	<p>Customize the sensitivity range of joystick towards each direction, so it could be better adjusted to every individual needs and requirements.</p>

System	Logo		The logo on the screen could be turned on or turned off.
	Time		Time and Date could be set here.
	Date		
	M/yd		The measuring distance unit could be set by meter or yard.

	Lang	 <p>System language could be set here.</p>
System	Version	 <p>We could check the information of current version here.</p>
	Reset	 <p>The settings of images could be reset here.</p>

<h1>System</h1>	<h1>Update</h1>		<p>You can adjust and upgrade the device system.</p>
-----------------	-----------------	---	--

EIS function: Turn on the EIS function to reduce the impact of body shaking on the image and keep the image stable when observing distant targets.

3.4.3 Network Connection

Select Internet icon to and press joystick to enter the Network Connection menu.



3.4.3.1 App Download

You may download the "ThermTec Outdoor" APP through the QR code shown on the packing box, user manual or below.



3.4.3.2 Connect via Hotspot

- Turn on device's hotspot.

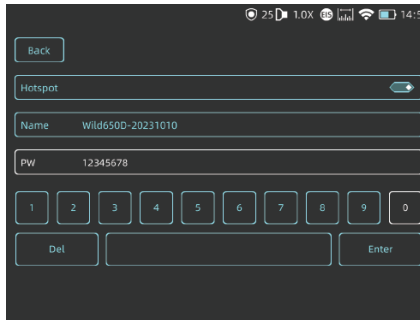
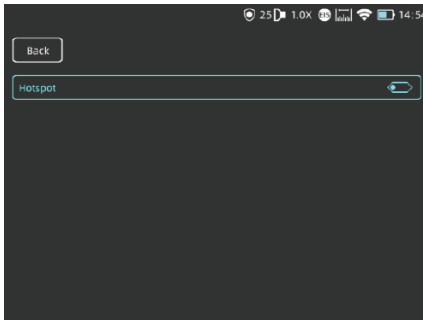

- Connect mobile client with device's hotspot.
- After the connection, you could control devices freely with APP (ThermTec Outdoor).

3.4.4 File Management

Select Files and press the joystick to enter the Files. Select the image and video sub-menus to view the images and videos and play the videos.

Image Viewing

- Press the joystick to enter image files.



- After selecting a certain image, press joystick to access further operations of the image, we could delete it, check next one or delete all the images.

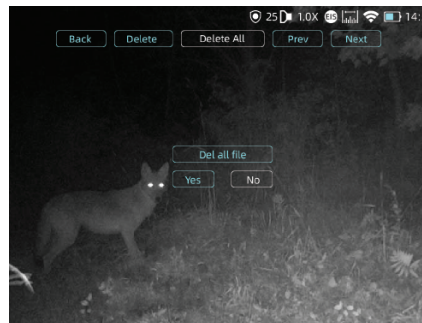
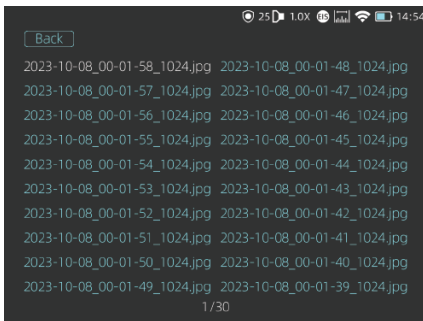

Video Viewing

- Select Record and press joystick to enter video files.
- Choose a certain video and press joystick to check the video.

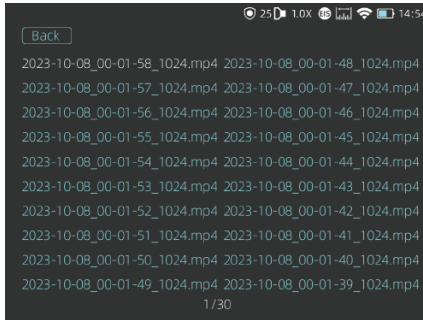

- Further operations could be accessed here, we could delete it, check next one, pause the video or delete all the videos.

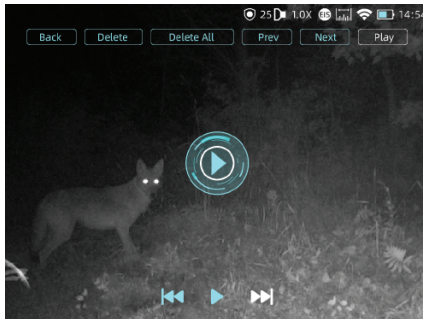

3.5 External Video & Data Reading

Video Output

Use the given AV video cable to output analog video.

Data Reading

When external display is connected, the OLED of the device automatically turns off. Power on the device, use a type-C USB cable to connect with the computer to read the video and image data in the memory.

Note: Videos, images and rav videos taken will be saved separately in folders named “record”, “image” and “rav”

3.6 System Software Upgrade

Wild series thermal imaging monocular supports “**ThermTec Outdoor**” APP, which allows you to transmit the image from the thermal imager to the smartphone or tablet via Hotspot in real time mode.

Upgrading via APP

- Open ThermTec Outdoor APP.
- Turn on the hotspot of the device, and connect it with the Mobile phone.
- Select Update on the menu options.
- The downloading and upgradation would be a continuous process if there is an update.
- After finishing the update, the device will reboot.

Upgrading via PC

- Please download corresponding upgrading package from official website. www.thermeyer.com. Connect the device to PC via Type-c data cable.



- Copy the related updating firmware to the storage file of Wild. Press joystick to select Update icon, and the system will prompt “Update”.

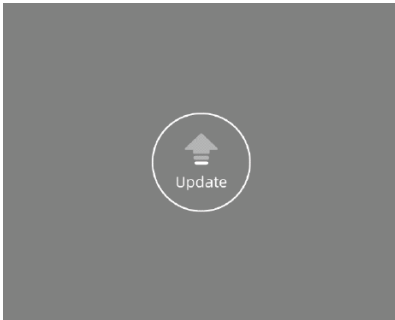

- Enter version to check firmware version.

4 Technical Data

4.1 Product Size & Drawing

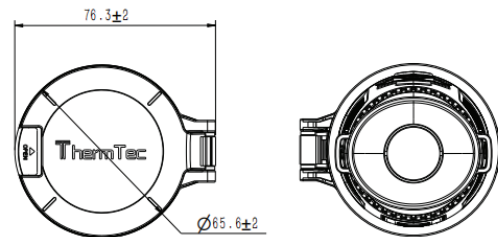
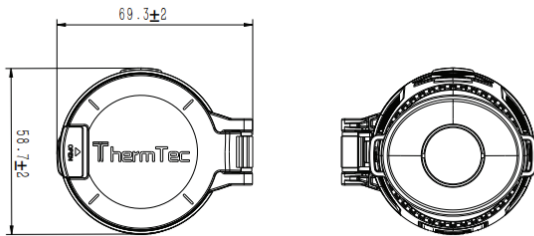
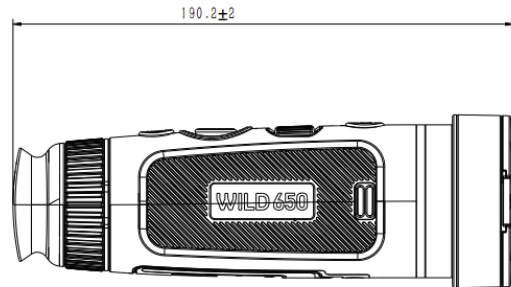
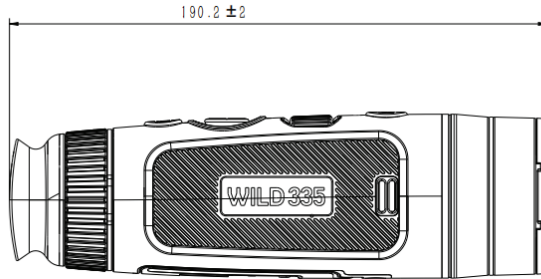

Note: Wild325, Wild335 and Wild635 are of the same size.

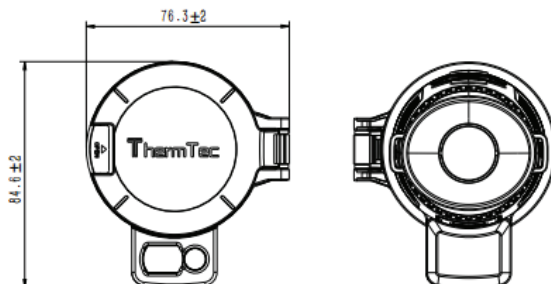
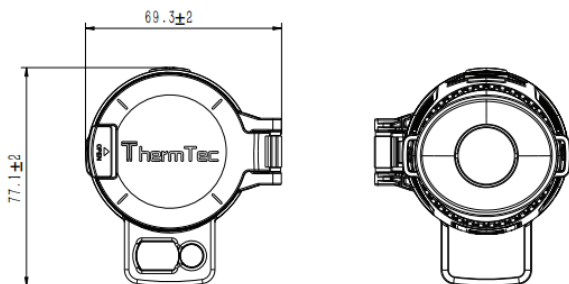
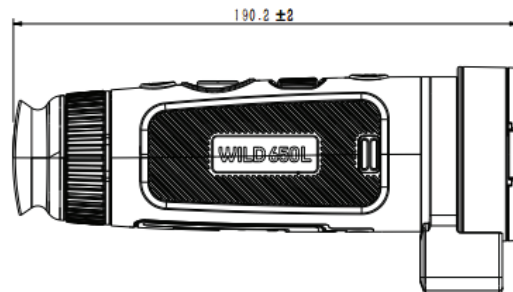
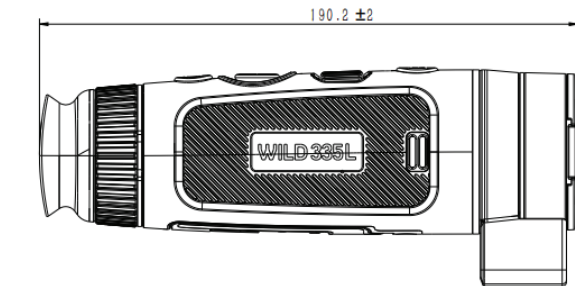

Note: Wild335L & Wild635L are of the same size.

4.2 Specifications

Specifications - Wild

Model	Wild325	Wild335	Wild635	Wild650
Microbolometer				
Resolution	384x288		640x512	
Pixel Pitch	12μm			
NETD	18mk@300k			
Spectral range	8-14μm			
Frame rate	50HZ			
Detection Range	1300m	1800m	1800m	2600m
Optics				
Objective lens	25mm/F0.8	35mm/F0.8	35mm/F0.9	50mm/F0.9
Field of view	10.5° x 7.9	7.5° x 5.6°	12.5° x 10°	8.8° x 7.0°
Magnification	2.4X	3.3X	2.0X	2.8X
Digital Zoom	1-4X continuous zoom			
Eye relief	40mm			
Exit pupil	6mm			
Diopter	±5D			
Display				
Type	AMOLED			
Resolution	1024x768			
Display size	0.39 inch			
Color palette	6			
Image mode	Forest/Outline			

	Function			
Photo/video playback	Yes			
Language	Multiple-languages			
Built-in Memory	64GB			
PIP	Yes			
AI Distance Measurement	Yes			
Heat Track	Yes			
Real-time Notification	Yes			
OSD Recording	Yes			
Burn prevention	Yes			
EIS	Yes			
Battery				
Internal battery	Replaceable and Rechargeable Li-ion Battery (18650x1)			
Battery life	10h	8h		
Interface				
Type-C	Supports battery charging, data transfer, USB video output			
Hotspot	Yes, App remote control			
Environment				
Working temperature	-20°C~+50°C			
Protection Level	IP67			
Weight, g	470±5g	485±5g	475±5g	510±5g
Size,mm	190.2(L)x69.3(W)x58.7(H)			190.2(L)x76.3(W)x65.6(H)
Accessories				
External Cable	USB cable			
Other Accessories	Palm strap/Protective bag/Non-dust cloth and etc.			

Specifications - Wild

Model	Wild335L	Wild635L	Wild650L
-------	----------	----------	----------

Microbolometer

Resolution	384x288	640x512	
Pixel Pitch	12μm		
NETD	18mk@300k		
Spectral range	8-14μm		
Frame rate	50HZ		
Detection Range	1800m	1800m	2600m

Optics

Objective lens	35mm/F0.8	35mm/F0.9	50mm/F0.9
Field of view	7.5° x 5.6°	12.5° x 10°	8.8° x 7.0°
Magnification	3.3X	2.0X	2.8X
Digital Zoom	1-4X continuous zoom		
Eye relief	40mm		
Exit pupil	6mm		
Diopter	±5D		

Display

Type	AMOLED		
Resolution	1024x768		
Display size	0.39 inch		
Color palette	6		
Image mode	Forest/Outline		

Function

Photo/video playback	Yes		
----------------------	-----	--	--

Language	Multiple-languages		
Built-in Memory	64GB		
PIP	Yes		
LRF Boost	Yes		
Heat Track	Yes		
Real-time Notification	Yes		
OSD Recording	Yes		
Burn prevention	Yes		
EIS	Yes		

Battery

Internal battery	Replaceable and Rechargeable Li-ion Battery (18650x1)		
Battery life	10h	8h	

Interface

Type-C	Supports battery charging, data transfer, USB video output		
Hotspot	Yes, App remote control		

Environment

Working temperature	-20°C~+50°C		
Protection Level	IP67		
Weight, g	515±5g	505±5g	540±5g
Size,mm	190.2(L)x69.3(W)x77.1(H)		190.2(L)x76.3(W)x84.6(H)

Accessories

External Cable	USB cable		
Other Accessories	Palm strap/Protective bag/Non-dust cloth and etc.		

Laser Rangefinder

Safety Class	Class 1		
Wavelength	905nm		
Range	1000m		
Accuracy	±1m		



ThermTec Technology Co., Ltd.
Email: info@thermeyetec.com
Web: www.thermeyetec.com



COPYRIGHT © 2023 ThermTec Technology Co., Ltd. ALL RIGHTS RESERVED.